



COREMO OCMEA S.P.A.

Via Galilei, 12 - 20090 Assago (MI) - Italy

Tel. +39 024880697 Fax +39 024881940

www.coremo.it info@coremo.it

User and Maintenance Manual

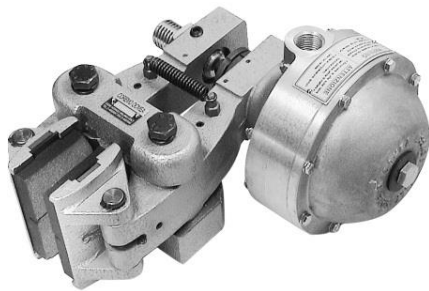

D Pneumatic failsafe

Model D-1N

Model D-2N

Model D-3N

Model D-3N/17kN

Model D-3.5N

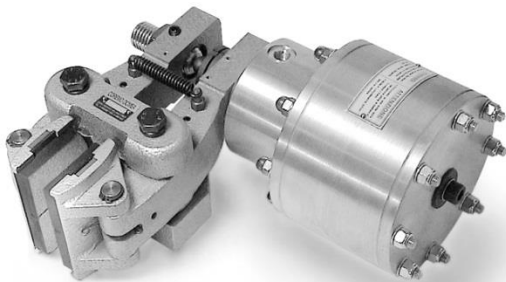

D Hydraulic failsafe

Model D2N-ID

Model D3N-ID

Model D3N-ID/17kN



ISO 9001 - Certificate N°0238

Translation of the original instructions
EN 130701 REV. 1



	User and Maintenance Manual <i>“D” Failsafe caliper brake</i>		Model D-1N Model D-2N and D2N-ID Model D-3N and D3N-ID Model D-3N/17kN and D3N-ID/17kN Model D-3.5N
	Date: 2013/07/01	Revision: 1	www.coremo.it

TABLE OF CONTENTS

1.	Introduction	3
2.	Manufacturer	3
3.	General information.....	3
4.	Warnings	5
5.	Technical data	5
5.1.	Product performance	5
5.2.	Brake lining wear	6
5.3.	Special note	7
6.	Transport and storage.....	7
7.	Installation.....	7
8.	Operation	11
8.1.	Power supply of the safety component	11
8.2.	Improper use	11
9.	Maintenance and cleaning.....	11
9.1.	Readjusting the play.....	12
9.2.	Changing the lining pads and cleaning the friction surfaces.....	12
9.3.	Changing the thruster springs	12
9.4.	Changing the gaskets.....	13
9.5.	Changing the brake shoe alignment springs	14
9.6.	Periodic maintenance.....	14
10.	Spare parts list.....	15

	User and Maintenance Manual <i>“D” Failsafe caliper brake</i>		Model D-1N Model D-2N and D2N-ID Model D-3N and D3N-ID Model D-3N/17kN and D3N-ID/17kN Model D-3.5N
	Date: 2013/07/01	Revision: 1	www.coremo.it

1. Introduction

The purpose of this manual is to provide the user with all the information necessary to use the product properly, independently and safely.

This manual constitutes an integral part of the safety features and must be read in its entirety before installation and use of the product. It must therefore be kept in a safe place should future reference be necessary before proceeding with any kind of work.

The user is strongly advised to read it carefully and to follow the rules and procedures contained in it as these provide important information concerning safe use and maintenance.

If any doubt should arise concerning the correct interpretation of the instructions, contact our technical department for the necessary clarification.

It is prohibited for anyone to disclose or modify the content of this manual or to use it for personal purposes.

2. Manufacturer

COREMO OCMEA S.P.A.

Via Galilei, 12 - 20090 Assago (MI) - Italy

Tel.: +39 024880697 Fax: +39 024881940

e-mail: info@coremo.it

3. General information

Correct use of the product: In compliance with Italian Legislative Decree 17/2010 and DIRECTIVE 2006/42/EC the operating limits for ideal and safe use of the product are stated in this manual.

Design parameters: COREMO OCMEA caliper brakes have been designed for use in conformity with the performance and conditions stated in the catalogue and Chapter 5.1 of this manual. It is advisable not to exceed these limitations.

Model selection: Selection of the correct model for a given application is of basic importance. When selecting a model an appropriate service factor must be taken into consideration. In the case of failsafe brakes the service factor must not be less than 2. The technical department of COREMO OCMEA can provide you with information, suggestions and assistance regarding correct application and use.

	User and Maintenance Manual <i>“D” Failsafe caliper brake</i>		Model D-1N Model D-2N and D2N-ID Model D-3N and D3N-ID Model D-3N/17kN and D3N-ID/17kN Model D-3.5N
	Date: 2013/07/01	Revision: 1	www.coremo.it

Use: Compliance with the assembly and maintenance instructions prevents not only costly down time but also accidents due to incomplete knowledge of the product.

Rotating parts: The caliper brakes are coupled mainly with rotating parts. In this case the moving parts must be protected in conformity with the requirements of DIRECTIVE 2006/42/EC and Italian Legislative Decree 17/2010 or equivalent legislation in force in the countries in which they are used.

Power source for pneumatic brakes: Use air not contaminated with oil or water and a 25 micron filter with automatic condensation discharge.

Power source for hydraulic brakes: Use mineral oil SAE/SO 46.

Failsafe spring brakes: Failsafe spring brakes must be handled with special care as they contain mechanically preloaded springs. To avoid the risk of accidents during maintenance it is necessary to follow the instructions in this manual and those highlighted in red on the label attached to the brake.

Friction material: All COREMO OCMEA caliper brakes are fitted with friction material which is absolutely free of asbestos and is declared as NON toxic/harmful in full observance of health and environment regulations and laws. In any case it is better not to inhale dust produced by them and to wash hands thoroughly before eating or drinking.

Oils, greases, lubricating components: These are used in extremely limited quantities. Personnel suffering from allergies to these substances are advised to wear gloves or use protective cream which must be washed off thoroughly before eating or drinking.

Product markings: All the data on the plates must always be kept legible. Use the data shown on the plates when contacting the manufacturer for spare parts, information or assistance for example.

Disposal: Worn brake lining pads and other materials of which brakes are made are classified as special NON toxic/harmful products and therefore must be disposed of in accordance with the laws in force in the countries in which they are used.

	User and Maintenance Manual “D” Failsafe caliper brake		Model D-1N Model D-2N and D2N-ID Model D-3N and D3N-ID Model D-3N/17kN and D3N-ID/17kN Model D-3.5N
	Date: 2013/07/01	Revision: 1	www.coremo.it

4. Warnings



Failure to follow the instructions in this manual and on any plates attached to the product exposes persons to risks and may cause damage to other equipment and machinery.

- The product must not be used at an ambient temperature lower than -20 °C.
- The disc must be made of iron alloy (cast iron or steel) having a hardness in the range 190 to 220 HB.

The technical department of COREMO OCMEA can provide additional information in order to ensure correct application and use of the product.

Dangers caused by a power failure: A power failure will cause the brake to be applied suddenly. It is therefore necessary to provide an uninterrupted power supply or, if the case requires, use suitable power failure warning systems as a brake failure may cause personal injury and damage to property.

Danger of breakage during operation: To reduce the risk of breakage during operation carry out the periodic inspections shown in this manual.

Risks connected with changes in operating conditions: The product is designed for the purposes stated in this user and maintenance manual therefore the minimum power supply pressure necessary to allow the brake to open and the maximum pressure required for the brake to work safely and reliably are indicated. The operating conditions also vary depending on the diameter of the brake disc used; this manual contains an equation to calculate the dynamic torque provided as a function of the disc diameter. Please note that an erroneous calculation may result in a braking torque different to the desired value which could compromise aspects of safety.

Residual risk: Residual risk can be attributed to the operator not following all the procedures stated in the user and maintenance manual and not giving due consideration to the warnings.

5. Technical data

5.1. Product performance

The failsafe brake is to be used for emergency stops or holding stops.



Use of the product for any purpose other than those indicated may represent a risk to any aspect of safety.

	User and Maintenance Manual “D” Failsafe caliper brake		Model D-1N Model D-2N and D2N-ID Model D-3N and D3N-ID Model D-3N/17kN and D3N-ID/17kN Model D-3.5N
	Date: 2013/07/01	Revision: 1	www.coremo.it

The type “D” failsafe caliper brakes are different basically due to the dimension of the pneumatic actuator (1N, 2N, 3N, 3.5N e 3N/17kN) or hydraulic actuator (2N-ID, 3N-ID e 3N-ID/17kN); the table below shows the tangential force for each brake type considering a coefficient of friction of 0.4

Warning: The value of the friction coefficient is purely theoretical as it depends on environmental conditions and on how the product is used.

TYPE	Tangential Force
D-1N	2625 N
D-2N	5250 N
D-3N	10400 N
D-3N/17kN	17000 N
D-3.5N	19260 N
D2N-ID	5600 N
D3N-ID	11200 N
D3N-ID/17kN	17000 N

The table shows the values obtained with 4 springs for a D-1N or D2N-ID brake, with 8 springs for a D-2N, D-3N or D3N-ID brake, with spring pairs for a D-3N/17kN or D3N-ID/17kN brake and with 12 springs for a D-3.5N brake; proportionately lower values can be obtained with 2 springs for a D-1N or D2N-ID brake, with 6, 4 or 2 springs for a D-2N, D-3N or D3N-ID brake, with a lower number of pairs of springs for a D-3N/17kN or D3N-ID/17kN brake.

▪ Dynamic torque

The dynamic torque provided by the brake will be a function of the diameter of the disc used for each single type of product and can be determined using the following equation:

$$\text{Dynamic torque [Nm]} = \text{Tangential force [N]} \times (\text{radius of the disc [m]} - 0.033)$$



An error in calculation will result in a braking torque different to the desired value and a risk to aspects of safety.

The technical department of COREMO OCMEA can provide information, suggestions and assistance for correct application and use of the product.

5.2. Brake lining wear



The thickness of each single new lining is 11 mm. A maximum overall lining wear of 12 mm is allowed. Failure to remain within the above limit may represent a risk to aspects of safety.

	User and Maintenance Manual “D” Failsafe caliper brake		Model D-1N Model D-2N and D2N-ID Model D-3N and D3N-ID Model D-3N/17kN and D3N-ID/17kN Model D-3.5N
	Date: 2013/07/01	Revision: 1	www.coremo.it

5.3. Special note

During braking kinetic energy is converted into heat caused by friction between the surfaces of the brake linings and the brake disc. It is therefore fundamentally important to consider the amount of heat that can be dissipated.

	<p>Ignoring the heat produced during braking affects brake lining wear and may jeopardize the safety of the operators and the reliability of the product. Since a brake can be used for many applications, it is advisable to contact the technical department of COREMO OCMEA for further explanation in this regard.</p>
---	--

6. Transport and storage

	<p>Personnel assigned to this work must wear suitable PPE such as gloves, safety footwear and take any other precautions necessary before proceeding with transport, handling and storage of the this part.</p>
--	---

1. **Transport:** When handling it is important to bear in mind the dimensions and weight of each single type of product as shown in the product drawing enclosed with this manual and in the catalogue of the brake type in question.
2. **Storage:** When storing brakes it is important to bear in mind that a considerable weight is concentrated in a small space. Personnel assigned to this work must wear suitable PPE (safety footwear, gloves, etc.) in order to avoid the risk of injury.

7. Installation

	<p>THE BRAKE MUST BE INSTALLED WITH THE MACHINE OFF.</p> <p>Personnel assigned to this work must wear suitable PPE such as gloves, safety footwear and take any other appropriate precautions to ensure adequate protection and avoid the risk of injury.</p>
---	--

Before installation, remove the spacer between the pads. To remove this spacer give pressure to the brake, as shown in the relative paragraph, after connecting it to the air supply through a 1/2" gas nipple (for 2N, 3N, 3N/17kN and 3.5N thrusters) or a 1/4" gas nipple (for 1N, 2N-ID, 3N-ID and 3N-ID/17kN thrusters). Tighten the TE safety screw on the rear of the thruster and

	User and Maintenance Manual “D” Failsafe caliper brake		Model D-1N Model D-2N and D2N-ID Model D-3N and D3N-ID Model D-3N/17kN and D3N-ID/17kN Model D-3.5N
	Date: 2013/07/01	Revision: 1	www.coremo.it

subsequently release the pressure on the thruster and disconnect the air inlet tube to proceed with the installation.

1. Mount the brake on a rigid flat surface of the machine or on a support capable of withstanding a certain tangential force as shown in Table 1.

Tangential force	Brake model
2888 N	D-1N
5775 N	D-2N
11440 N	D-3N
18700 N	D-3N/17kN
21186 N	D-3.5N
6160 N	D2N-ID
12320 N	D3N-ID
18700 N	D3N-ID/17kN

Table 1

The brake can be mounted in any position as it is provided with a balancing system for the levers and alignment of the brake shoes. Anchor the brake to the supporting base using 3 class 8.8 M12 screws and a tightening torque of 85 Nm.

2. Adjust the play between the brake linings and the disc using the play adjuster and a n. 12 Allen key, rotating in the appropriate direction (Figure 1); when a play of 1 mm has been obtained between the disc and each brake lining, lock the adjuster in position screwing the nut (C61600) all the way down using a n. 36 spanner and locking the adjuster (C61728) using a n. 5 Allen key. Adjust the screw located between the levers using a n. 10 spanner (Figure. 1), until the weight of the thruster is balanced; when balanced lock the screw by tightening the nuts.

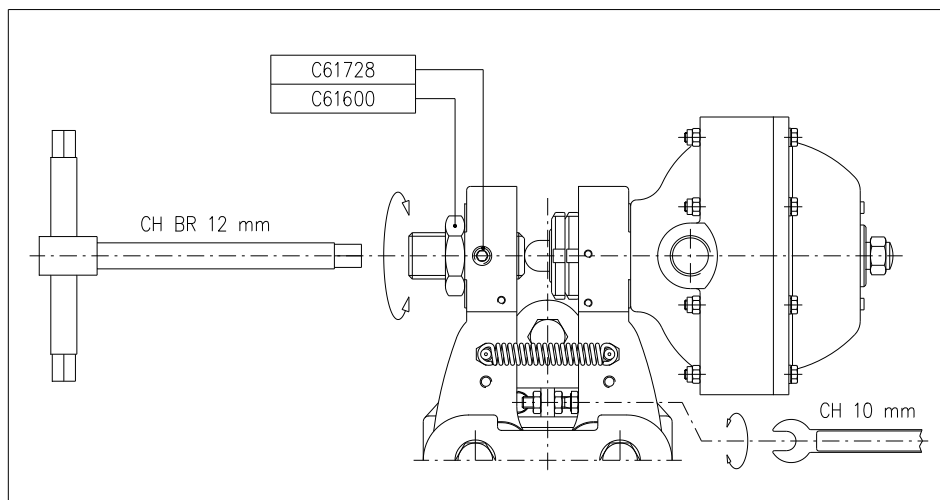

Figure 1

- Adjust the brake shoes using the grub screw C61724 rotating it in the appropriate direction with a n. 3 Allen key; the friction surface of the brake linings must be parallel to the surface of the disc (Figure 2).

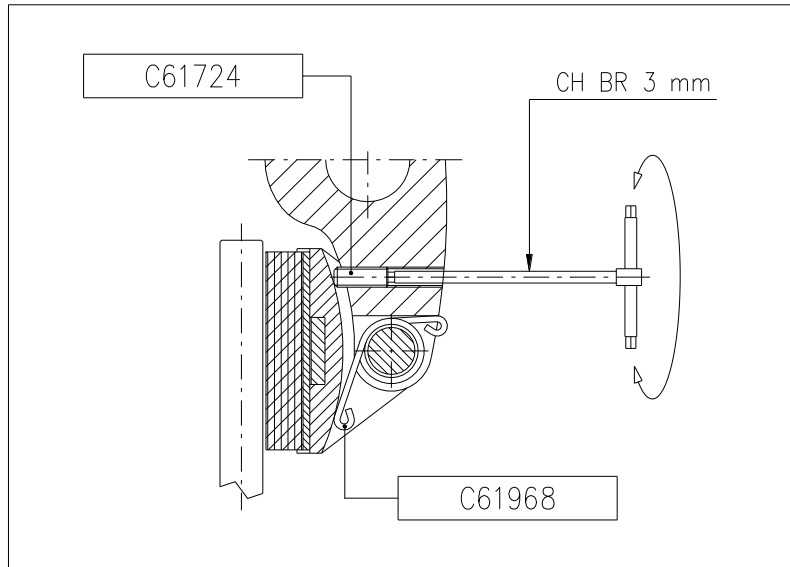

Figure 2

- Connect the thruster piston of the brake to the power line using a 1/2" gas fitting for the 2N, 3N, 3N/17kN and 3.5N thrusters or 1/4" gas fitting for the 1N, 2N-ID, 3N-ID and 3N-ID/17kN thrusters and a flexible hose of sufficient length to allow the thruster a wide range of movement.
- PNEUMATIC THRUSTERS:** The control pressure must not exceed 6 bar and drop below 5 bar for the 1N, 2N, 3N and 3.5N thrusters; the control pressure must not exceed 8 bar and drop below 7.5 bar for the 3N/17kN thruster. The air must not be contaminated with oil or water, therefore a 25 micron filter with automatic condensate discharge should be used.
HYDRAULIC THRUSTERS: The control pressure must not exceed 100 bar and drop below 25 bar for the 2N-ID thruster, 50 bar for the 3N-ID thruster and 70 bar for the 3N-ID/17kN thruster. The thruster must be powered exclusively with mineral oil hydraulic fluid.
- Power up the thruster and substitute the safety screw TE with the silencer C61126 (Figure 3).
N.B.: The 1N thruster does not have a silencer, therefore substitute the screw TE with the adjusting grub screw C61587 complete with nut C61598.

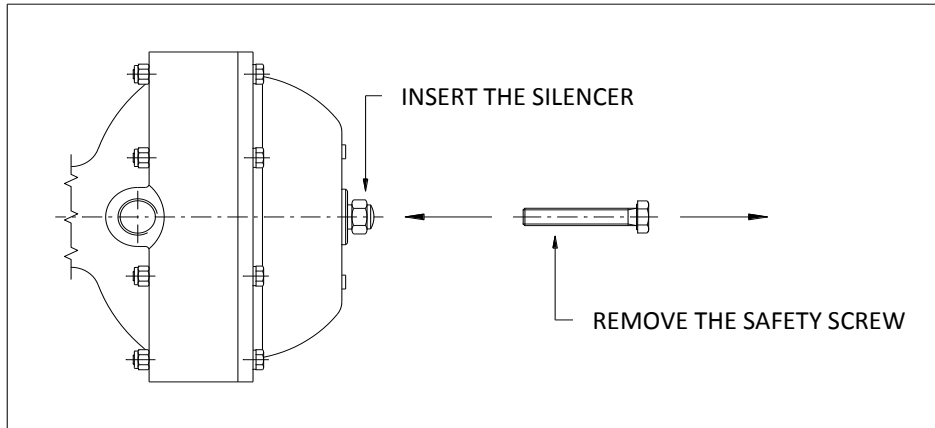

Figure 3



Do not apply the brake without the disc positioned between the brake linings; failure to follow this rule could result in fingers being crushed and other dangers in addition to damage to the brake itself.

- 7. HYDRAULIC BRAKES:** Bleed air out of the oil circuit by loosening the grub screw C61961 with a n. 4 Allen key, until oil begins to come out. When all the air has been bled out tighten the grub screw again (Figure 4).

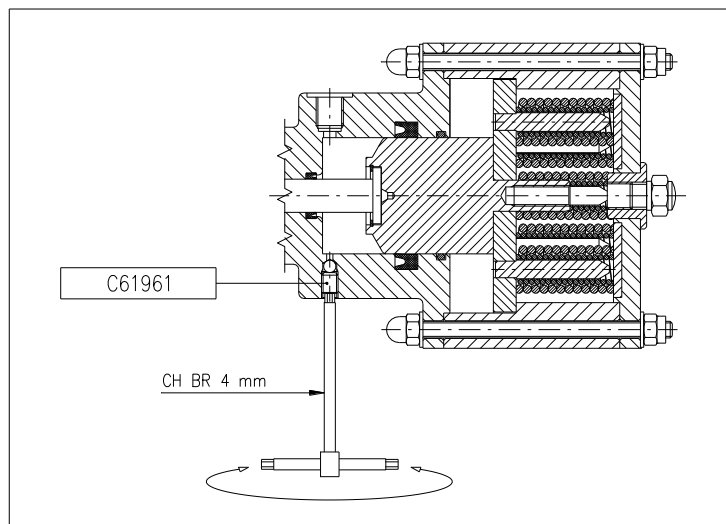



Figure 4



Personnel assigned to these operations must take special care, working cautiously when bleeding the circuit, wearing suitable PPE such as gloves, goggles and safety footwear and taking any other precautions necessary before proceeding.

- 8. BEDDING-IN:** The initial braking torque may be from 30% to 50% less than the rated value until the brake lining adjusts to the disc.

	User and Maintenance Manual “D” Failsafe caliper brake		Model D-1N Model D-2N and D2N-ID Model D-3N and D3N-ID Model D-3N/17kN and D3N-ID/17kN Model D-3.5N
	Date: 2013/07/01	Revision: 1	www.coremo.it

8. Operation

8.1. Power supply of the safety component

The power supply pressure varies depending on the component as indicated in Chapter 7. To open the pneumatic brake a minimum supply pressure of 5 bar is necessary, except for the brake D-3N/17kN for which is required a minimum supply pressure of 7.5 bar; for the hydraulic brake instead a pressure of 25 bar is required for the D2N-ID brake, 50 bar is required for the D3N-ID brake and 70 bar is required for the D3N-ID/17kN brake. The maximum supply pressure for a hydraulic brake is 100 bar.

The technical department of COREMO OCMEA can provide information, suggestions and assistance for correct application and use of the brake.

8.2. Improper use

The products considered here must be used exclusively as described in Chapter 5 of this manual. Any other use is to be considered improper. The manufacturer declines all responsibility for damage caused by erroneous or unreasonable use of the product.



Use of the product for purposes other than those stated in this manual may compromise any aspect of safety.

9. Maintenance and cleaning



ALL TYPES OF WORK ON THE BRAKE MUST BE DONE WITH THE MACHINE OFF.

Staff assigned to this work must wear suitable PPE such as gloves and safety footwear and take any further precautions necessary to ensure adequate protection and prevent injury. Failure to follow the instructions given for maintenance and cleaning of the product may compromise personal safety and cause damage to equipment and machinery.



High temperatures may be produced after braking on the surfaces of the disc brake and the brake linings. Personnel must therefore wait for parts subject to overheating to cool down and wear suitable protective gloves and PPE.

	User and Maintenance Manual “D” Failsafe caliper brake		Model D-1N Model D-2N and D2N-ID Model D-3N and D3N-ID Model D-3N/17kN and D3N-ID/17kN Model D-3.5N
	Date: 2013/07/01	Revision: 1	www.coremo.it

9.1. Readjusting the play

1. Power up the thruster, loosen the nut C61600 and grub screw C61728.
2. Rotate the play adjuster clockwise until the optimal play of 1 mm is obtained between the disc and each brake lining as described in point 2 of Chapter 7.
3. Lock the nut C61600 and the grub screw C61728 (Figure 1).
4. Realign the brake shoes as described in point 3 of Chapter 7.

9.2. Changing the lining pads and cleaning the friction surfaces

1. Power up the thruster and replace the silencer, or the adjusting grub screw for the 1N thruster, with the safety screw.
2. Remove the seeger rings C61275, then pull out the pin C61110 and remove the shoe Z50263.
3. Remove the worn linings levering the metal part to overcome the force of the magnet which holds it in its seat. Check that the magnet is well housed in the shoe.
4. Remove any oil or grease from the surface of the disc using a non-pollutant detergent.
5. If the lining pads are contaminated only superficially it is better to clean them using fine emery cloth. If the contamination of the linings is deep or at the maximum wear limit as indicated in Chapter 5.2 and stated in the catalogue, replace them with new linings.
6. Reassemble the shoe following the sequence in point 2 in reverse order, positioning the shoe alignment spring C61968 as indicated in Figure 2.
7. Readjust the play between the disc and lining as described in Chapter 9.1.
8. Replace the safety screw with the silencer, or the adjusting grub screw for the 1N thruster.

9.3. Changing the thruster springs

1. Power up the thruster. Unscrew the ring nuts and remove the thruster from the brake. Cut off the pressure to the thruster and disconnect the power line.
2. Remove the screws that anchor the thruster body to the cover (for the 1N thruster remove the nut, the adjusting grub screw and the seeger ring C61304); unscrew slowly and carefully so that the preloaded springs are released gradually.



Take the utmost care in these operations as the thrusters contain preloaded springs. Therefore proceed gradually with the utmost care and attention until they are completely released and no longer represent a threat to safety.

3. Remove the cover (for the 1N thruster remove the adjustment disc C62082 and the spring thruster disc C62081); replace all the springs including those which seem to be in good condition.
4. **Thruster 1N:** Put back the two discs, the seeger ring, the adjusting grub screw and the nut.

	User and Maintenance Manual “D” Failsafe caliper brake		Model D-1N Model D-2N and D2N-ID Model D-3N and D3N-ID Model D-3N/17kN and D3N-ID/17kN Model D-3.5N
	Date: 2013/07/01	Revision: 1	www.coremo.it

Thruster 2N: Rest the cover on the springs, align the anchoring holes, insert the screws complete with flat washers in their seats. Remove the silencer, insert the safety screw and tighten preloading the springs until the cover comes into contact with the thruster body. Tighten the anchoring screws following a diagonal sequence, locking the unit in position with the self-locking nuts. Replace the safety screw with the silencer.

Thrusters 3N, 3N/17kN, 2N-ID, 3N-ID, 3N-ID/17kN: Rest the cover on the springs, align the anchoring holes, insert the screws complete with flat washers in their seats and tighten following a diagonal sequence locking the unit in position with the self-locking nuts.

5. Reconnect the flexible hose and power up the thruster. Remount the thruster on the brake locking it in position with the two ring nuts.
6. Apply the brake a number of times to ensure that the internal thruster slides perfectly and check for any air leaks (for pneumatic thrusters) or oil (for hydraulic thrusters).

9.4. Changing the gaskets

1. Power up the thruster. Unscrew the ring nuts and remove the thruster from the brake. Cut off the pressure to the thruster and disconnect the power line.
2. Remove the screws that anchor the thruster body to the cover (for the 1N thruster remove the nut, adjusting grub screw and seeger ring C61304); slowly and carefully unscrew allowing the preloaded springs to release gradually.



Take the utmost care in these operations as the thrusters contain preloaded springs. Therefore proceed gradually with the utmost care and attention until they are completely released and no longer represent a threat to safety.

3. Remove the cover (for the 1N thruster remove the adjustment disc C62082 and spring thruster disc C62081); carefully pull out the internal thruster / plate. Remove the damaged gaskets and replace them with new ones. It is advisable to replace all the gaskets to avoid further down time of the machine. Before placing the new gaskets in their seats, lubricate with lithium soap grease, mineral oil and solid lubricants. Grease the thruster stem too before remounting the internal thruster / plate unit.
4. **Thruster 1N:** Put back the two discs, the seeger ring, the adjusting grub screw and the nut.
Thruster 2N: Rest the cover on the springs, align the anchoring holes, insert the screws complete with flat washers in their seats. Remove the silencer, insert the safety screw and tighten preloading the springs until the cover comes into contact with the thruster body. Tighten the anchoring screws following a diagonal sequence, locking the unit in position with the self-locking nuts. Replace the safety screw with the silencer.
Thrusters 3N, 3N/17kN, 2N-ID, 3N-ID, 3N-ID/17kN: Rest the cover on the springs, align the anchoring holes, insert the screws complete with flat washers in their seats and tighten following a diagonal sequence locking the unit in position with the self-locking nuts.
5. Reconnect the flexible hose and power up the thruster. Remount the thruster on the brake anchoring it in with the two ring nuts.

	User and Maintenance Manual <i>“D” Failsafe caliper brake</i>		Model D-1N Model D-2N and D2N-ID Model D-3N and D3N-ID Model D-3N/17kN and D3N-ID/17kN Model D-3.5N
	Date: 2013/07/01	Revision: 1	www.coremo.it

- Apply the brake a number of times to ensure that the internal thruster slides perfectly and check for any air leaks (for pneumatic thrusters) or oil (for hydraulic thrusters).

9.5. Changing the brake shoe alignment springs

- Power up the thruster and replace the silencer, or adjusting grub screw for the 1N thruster, with the safety screw.
- Remove the seeger rings C61275, then pull out the pin C61110 and remove the brake shoe Z50263.
- Remove the shoe alignment spring C61968 from its seat and replace it with a new one positioning it as shown in Figure 2.
- Remount the brake shoe following the procedure in point 2 in reverse.
- Readjust the play between the disc and the lining as described in Chapter 9.1.
- Substitute the safety screw with the silencer, or adjusting grub screw for the 1N thruster.

9.6. Periodic maintenance



All inspections must be done with the machine switched off.

Although the intervals between these inspections depend on the frequency of use of the brake, they should be done every 3 months in any case so as not to compromise all aspects of safety.

- Check that the play between each lining pad and the friction disc does not exceed 1 mm. If the play is too large, adjust it to the initial value as described in Chapter 9.1. When the wear of each lining reaches 6 mm replace it as described in Chapter 9.2.
- Check that the surfaces of the linings and the disc are not contaminated with grease, oil or similar substances because these prevent the brake from working effectively.
- Check that the anchoring screws of the brake and the brake units are correctly tightened.
- Check the condition of the flexible hoses.
- Apply the brake a number of times to check the condition of the gaskets, the operation of the springs and correct sliding of the stem.

	User and Maintenance Manual “D” Failsafe caliper brake		Model D-1N Model D-2N and D2N-ID Model D-3N and D3N-ID Model D-3N/17kN and D3N-ID/17kN Model D-3.5N
	Date: 2013/07/01	Revision: 1	www.coremo.it

10. Spare parts list

To avoid costly down time we recommend keeping a stock of spare parts adequate for the number of brakes as listed below:

Lining pads:	Cod. N° Z50054	ST 10	
	Cod. N° Z50055	ST 11	
	Cod. N° Z50117	ST 10	with wear indicator
	Cod. N° Z50118	ST 11	with wear indicator
Thruster springs:	Cod. N° C61948		Thrusters 1N and 2N
	Cod. N° C60986 - C61945		Thrusters 3N and 3N/17kN
	Cod. N° C62074		Thruster 3.5N
	Cod. N° C60986 - C61945		Thruster 2N-ID, 3N-ID, 3N-ID/17kN
Shoe alignment springs:	Cod. N° C61968		
Lever balance springs:	Cod. N° C61951		with disc of thickness 12,7 mm
	Cod. N° C61952		with disc of thickness 25,4 mm
	Cod. N° C61953		with disc of thickness 30 or 40 mm
Gaskets:	Cod. N° C62083 - C61129		Thruster 1N
	Cod. N° C61127 - C61129		Thruster 2N
	Cod. N° C61128 - C61129		Thruster 3N and 3N/17kN
	Cod. N° C61976 - C61129 - C62072		Thruster 3.5N
	Cod. N° C61976 - C61977		Thruster 2N-ID, 3N-ID and 3N-ID/17kN
	Cod. N° C61978 - C61979		Thruster 2N-ID, 3N-ID and 3N-ID/17kN

These spare parts must be kept in a place that is preferably dark, cool and far from substances that could reduce their functionality.